

SONY®



# HVR Series

Digital HD Video Camera Recorder

**HVR-Z7U**

**HVR-S270U**

Digital HD Videocassette Recorder

**HVR-M35U**

[www.sony.com/HDV](http://www.sony.com/HDV)

**HDV**

**PROGRESSIVE**

# Interchangeable Lens System, Native Progressive Recording, and Solid-state Memory Recording – Sony’s Commitment to the HDV World Brings a Remarkable Evolution in Next-generation Products.

Sony is proud to introduce two new HDV™ camcorders that deliver the enhanced functionality professionals have been waiting for: an interchangeable lens system, native progressive recording, and solid-state memory recording. Introducing the HVR-Z7U, the world’s first HDV handheld camcorder that uses 1/3-inch bayonet joint interchangeable lenses, and the HVR-S270U shoulder-mount camcorder, which supports standard-size cassettes for extended recording times. A streamlined nonlinear editing workflow can be achieved using the supplied Memory Recording Unit, which provides HDV/DVCAM/DV file recording on a widely available CompactFlash® solid-state memory card. These groundbreaking new camcorders feature 1080/24p/30p HDV native progressive recording modes\*<sup>1</sup> and they also have HDMI or HD/SD-SDI output.

This next-generation system features the HVR-M35U Video Cassette Recorder, which has HD/SD-SDI output. These new solutions enhance the operational versatility of the Sony’s professional HDV lineup, and open up a world of possibilities for high-definition digital video production. Whether it’s for documentaries, mainstream news, low-budget movies, music videos, Internet, education, or a wide range of industrial applications, Sony’s new HDV camcorders are ideal.

<sup>\*1</sup> In this brochure, “24p” means “23.98p” video signal and “30p” means “29.97p” video signal.



**HDV**  
HDV 1080i

**3 ClearVid**  
CMOS sensor

**Exmor™**

**PROGRESSIVE**

## ■ HVR-Z7U

(with supplied lens)



(with ENG lens\*)



(with Cinema lens\*)







■ HVR-M35U

■ Memory Recording Unit  
(supplied with the HVR-Z7U/S270U)

■ HVR-S270U

(with supplied lens)

(with ENG lens\*)

(with Cinema lens\*)



\*These lenses, adaptors and matte box sets are not supplied.

## New Lineup Expanding the HDV format World

Sony's commitment to HDV has resulted in the remarkable evolution of cutting-edge technology equipment, such as the HVR-Z7U and HVR-S270U, which use the popular HDV1080i recording specification.

The HDV1080i specification uses one of the "MPEG2 Long GOP" compression profiles. This highly efficient and robust "MPEG2 Long GOP" codec - which is also used in the Sony XDCAM HD™ and XDCAM EX™ series - enables users to record stunning-quality HD video.

The HVR-Z7U provides over 60 minutes\*2 of recording time using the widely available miniDV videotape. While the HVR-S270U has the additional option of using standard-size cassettes that provide over 4.5 hours\*3 of continuous recording.

\*2 When Sony's recommended Professional HDV tape DigitalMaster™ model PHDVM-63DM is used, approx. 63 min. recording time.

\*3 When Sony's recommended Professional HDV tape DigitalMaster™ model PHDV-276DM is used, approx. 276 min. (4 hrs. 36 min.) recording time.

# HDV

## HDV 1080i

## Switchable Recording and Playback – HDV1080i/DVCAM/DV

The HVR-Z7U and HVR-S270U can switch between HDV 1080i, DVCAM, and DV recording, providing full flexibility to record in either standard definition or high definition depending on your production needs



Native editing in the HDV format is now supported by most popular NLE (Nonlinear editing) software.

Additionally, the HDV signals can be recorded as a file on non-tape media. For example, when using the supplied CompactFlash (CF) Memory Recording Unit - images can be stored on a standard CF card for quick nonlinear editing. The optional HVR-DR60 Hard Disk Recording Unit can be used in the same manner, with images being recorded on to its large-capacity 60GB hard drive, which provides 4.5 hours of recording time.



PHDVM-63DM

PHDV-276DM



Memory Recording Unit (supplied)\*  
\*CF card is not included.

HVR-DR60 (optional)

## Built-in Down-converter for SD Production

The HVR-Z7U and S270U can convert material from 1080i down to 480i, and output the video signals through its i.LINK® interface and other SD output connectors.\*

This allows users to edit recorded material with a compatible nonlinear editing system using current DV editing software, as well as record SD signals to an external VTR.

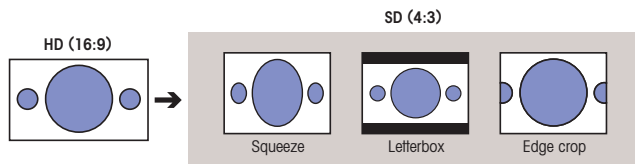

\*Letterbox mode is not available from the i.LINK connector. i.LINK is a trademark of Sony used only to designate that a product contains an IEEE 1394 connector. Not all products with an i.LINK connector will necessarily communicate with each other. For information on compatibility, operating conditions, and proper connection, please refer to the documentation supplied with any device with an i.LINK connector. For information on devices that include an i.LINK connection, please contact your nearest Sony office.

# Cutting-edge imaging System for New Camcorders

## ❖ 1/3 inch-type 3 ClearVid CMOS Sensor system

The newly developed 1/3-inch type 3 ClearVid™ CMOS Sensor system has 45-degree rotated pixels on each chip in order to increase the signal density, while each pixel maintains sufficient surface area.

In combination with Enhanced Imaging Processor™ (EIP), the 3 ClearVid CMOS Sensor system achieves high resolution, high sensitivity, wide dynamic range, and excellent color reproduction.

The pixel shift interpolation technique has been traditionally used in small 3CCD camcorders. However, it normally requires the combination of all three color element (RGB) signals to maximize resolution. If an object lacks one or more color elements, the resolution of the object may be degraded.

The 3 ClearVid CMOS Sensor system is different. It can always produce maximum resolution, regardless of the balance between color elements, thanks to its unique and sophisticated interpolation technology.

**3 ClearVid**  
CMOS sensor

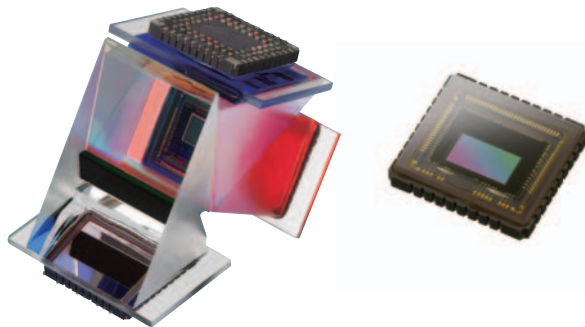

Pixel Layout

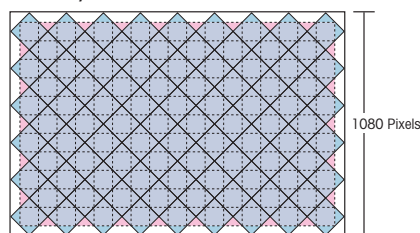

- ◆ Pixels (Photo Diodes)
- Signals after interpolation

## ❖ Enhanced Functionality via the Technology of Exmor

Both the HVR-Z7U and HVR-S270U offer cutting-edge features, such as the technology of Exmor™ developed by Sony, which utilizes the full potential of the 3 ClearVid CMOS Sensor system.

The technology of Exmor, which features the column-parallel A/D conversion technique and the dual noise cancelling method are also used in other camera products from Sony.

Multiple A/D (analog to digital) converters on each pixel row convert analog signals to digital as soon as they are generated, unlike traditional technology that only has one A/D converter on each chip. The technology of Exmor can eliminate the influence of external noise that enters the signal chain during transfer to the A/D converter, resulting in high-quality digital signals with extremely low noise. This significantly enhances shooting in low-light environments.

By adopting this groundbreaking technology, the new 1/3-inch 3 ClearVid CMOS Sensor system enables the HVR-Z7U and HVR-S270U to achieve a low light sensitivity of just 1.5 lux\*.

\* At 1/30 shutter, auto iris and auto gain

Current Technology

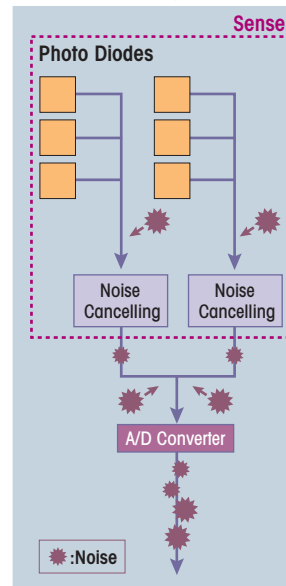

Technology of "Exmor"

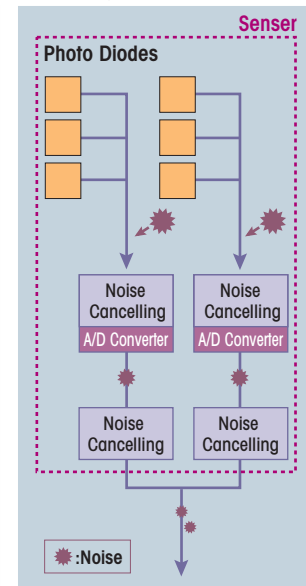

**Exmor™**



# Interchangeable Lens System Offers Unlimited Possibilities

Various video lenses can be attached to the HVR-S270U and HVR-Z7U, which are both equipped with a universal standard 1/3-inch bayonet mount mechanism for quick changing of lenses.

## ✦ Carl Zeiss Lens for HD Video as Standard

A high-quality, multi-purpose Carl Zeiss lens for HD video comes as standard with the HVR-S270U and HVR-Z7U. Stunning resolution and contrast is achieved thanks to the Carl Zeiss Vario-Sonnar™ T\* coating, which suppresses unwanted reflections. A specially designed wide-angle lens is also available as an option, to suit a diverse range of shooting requirements.

Lens		Optical Zoom	Focal Length**	F number
Standard lens (supplied)	VCL-412BWH (for HVR-Z7U)	12x	32mm-384mm (16:9)	1.6 - 2.0
	VCL-412BWS (for HVR-S270U)			
Wide lens (option)	VCL-308BWH (for HVR-Z7U)	8x	24mm-192mm (16:9)	1.6 - 2.4
	VCL-308BWS (for HVR-S270U)			

\*\*4 These values are calculated to be equivalent to 35 mm film.

## ✦ Easy-to-use Interchangeable Lens for Fixed-lens Camcorder Users

These lenses give Sony's two new HDV camcorders the same functionality as popular fixed-lens camcorders like the HVR-Z1U and HVR-V1U, thanks to built-in features such as auto-focus, optical stabilizer, and automatic back-focus adjustment.

Current users of the above camcorders will easily become adept at using the HVR-Z7U and HVR-S270U, even if they have never used interchangeable lenses.

## ✦ Natural-touch Lens Operation

### Focus

The newly designed focus ring offers two types of manual focus, plus an auto focus mode that can be easily switched by sliding the focus ring forward or backward.

When the focus ring is in the front position, the lens works in the same way as the HVR-Z1U, HVR-V1U, and DSR-PD170. In this case, either manual or auto focus mode can be selected by the assignable button on the lens. On the other hand, when the focus ring is set to the rear position, the focus ring has a physical stop at infinity and works in the same way as a professional interchangeable lens, with fixed-focus-position and distance indicators.

### Zoom

Fast, intuitive manual-zoom response is provided by an internal gearwheel mechanism that provides accurate zoom positioning. A high-quality servo-motor provides the smooth zooming performance that industry professionals have come to rely on.

### Iris

The iris ring encircles the lens barrel. Manual iris adjustment is possible with an ENG-type ring system that allows fine exposure control for challenging lighting situations.

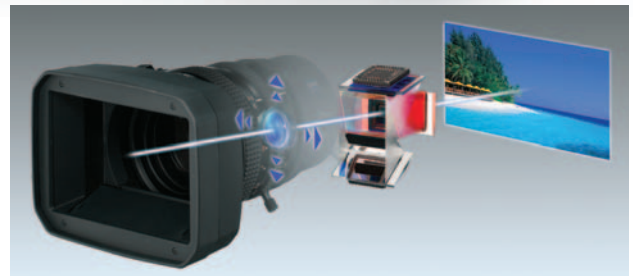

Front : AF/MF

Back : Full MF

### AF/MF Mode

- Full AF
- MF with One-push AF

### Full MF Mode

- Full MF (absolute focus position)

## ✦ Wide Range of Lenses

The flexible bayonet lens attachment system allows you to use a wide range of lenses.

Standard 1/3-inch HD video lenses, from manufacturers such as Fujinon and Canon, can be attached directly to the HVR-Z7U and HVR-S270U.

If you'd like to attach a 2/3-inch or 1/2-inch HD video lens on the HVR-Z7U or HVR-S270U, it is possible to do so by adding a standard lens adaptor from the lens manufacturer.

The HVR-S270U and HVR-Z7U camcorders have 12-pin lens connectors allowing compatibility with professional ENG lenses.

This feature is very useful not only for those who already have these professional HD video lenses, but also for those who prefer to use HD digital cinema lenses for their unique contrast, color, and atmosphere.



Lens adaptor



Cinema lens on HVR-S270U with an adaptor

## ✦ $\alpha$ Lens Compatibility

With a special adaptor from Sony, it is also possible to use the  $\alpha$ ™ lens series designed for Sony Digital SLR still cameras.

By using  $\alpha$  lenses in various configurations, creative effects can be achieved.

This approach is ideal for filmmakers on a budget or those who already own  $\alpha$  lenses.

### Note:

The focal length is doubled with a 2/3-inch lens adaptor

The focal length is increased 1.3 times with a 1/2-inch lens adaptor

The focal length is increased 7 times with an  $\alpha$  lens adaptor

Some lenses may not be compatible and not all lens functions may be available



$\alpha$  lenses

# Operational Versatility

## ✦ New Manual Camera settings

### Three ND filters (1/4, 1/16, 1/64)

The HVR-Z7U and HVR-S270U have three built-in ND (Neutral Density) filters, which help users to reduce light intensity under bright shooting conditions.

### Negative Gain

Negative gain settings of -6 and -3 dB have also been added to help reduce sensitivity under bright lighting conditions. When the iris needs to be opened to create a short depth of field, a suitable brightness can be achieved with this function.

### Smooth Gain

The Smooth Gain function is a smooth transition gain system that avoids sudden brightness changes caused by manual gain-level adjustment. With this function, the brightness changes gradually when the gain-level position is switched and avoids any sudden, unwanted iris adjustment.

### Smooth WB (White Balance)

The Smooth WB feature is a smooth transition white balance system that avoids unnatural sudden color temperature changes between preset white balance settings. For example, this function is useful when you move from an artificial, low-light environment inside a building, to bright natural sunlight outside.



Three ND filters

## Shooting Support Functions

### Advanced Histogram

The Histogram Indicator for brightness can be displayed on the LCD monitor and viewfinder, allowing operators to easily evaluate the brightness of captured images. A target window appears in the center of the screen and the brightness level is indicated by a vertical red line in the histogram. The zebra indicator level appears as a yellow vertical line in the histogram as reference for proper exposure.

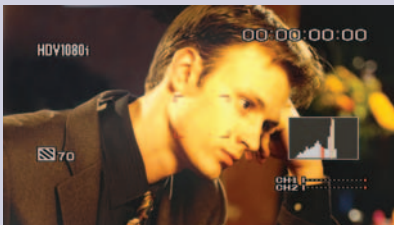

### Focus Marking

When the focus position needs to be manually moved to pre-decided positions, you can put up to two markers (A and B) on a focus position indicator in the LCD/EVF as reference points. When the focus position becomes aligned with one of these markers, it will begin to flash. This allows you to keep your eye on the subject of your shot, without having to check the focus indicator on the lens.



### Camera Leveling

The HVR-Z7U and HVR-S270U both have a built-in three-dimensional gravity (3G) sensor, which detects the horizontal level of the camcorder and displays it via an indicator in the LCD/EVF. This digital leveler function makes it possible to obtain a horizontal level reading even when shooting without a tripod.



### AE Window

Six types of AE (Auto Exposure) can be selected to automatically adjust the exposure to the most suitable level.

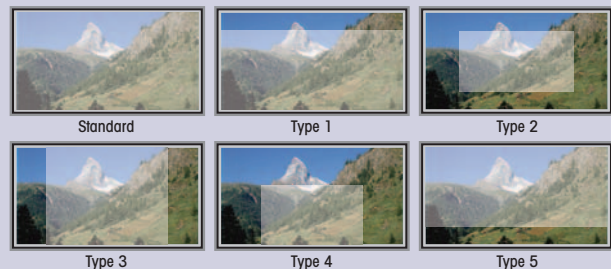



### Picture Profile

Up to six different picture-quality settings, including gamma and color settings, can be registered in the memory as picture profiles. This labor-saving function allows operators to easily recall customized picture-quality settings for various shooting conditions. It is also useful for matching footage shot at different times or for multi-camera setups.

The picture-profile functions of the HVR-Z7U and HVR-S270U include enhanced versions from the HVR-Z1U or HVR-V1U, plus a selection of new functions.

### Color Depth

Generally, the brightness of a video image increases as the color level becomes more vivid. In these new camcorders, the brightness and color level are processed independently so that more flexible tone – for instance, a dark image with a vivid color – is realized by 3D-LUT color processing.

Note: 3D-LUT = three-dimensional look-up table

### Color Correction

The Color Correction function of the HVR-Z1U has been improved in the HVR-Z7U and HVR-S270U camcorders. Color Correction provides two functions for creative shooting. The Color Extraction function can retain up to two desired colors of monitored pictures in the screen, while making all other colors black and white. The advanced function allows users to select the color simply by pressing a button to memorize the center color of the captured image.

The Color Revision function can change the hue of only the color designated by the Color Extraction function. This function is good not only for creating impressive images, but also for blue- or green-screen shooting in order to normalize uneven color.

The color data is stored in each Picture Profile so that users can select the most suitable color setting for each shooting situation.



Color Correction Images Simulated

### WB Shift

The WB (White Balance) Shift function allows users to create an impressive color or to adjust the color temperature of the camcorder.

There are two WB Shift options to choose from:

- LB-CC type: adjusting the LB axis (color temperature) and CC filter effect
- R-B level type: adjusting the red and blue levels

### Skintone Detail

This function allows users to change the sharpness of an object with a specific color, and is particularly good for making skin tones look more natural. The target color can be specified by controlling the Phase/Range/Saturation/Y Level/Y Range parameters or by pressing a button to specify the color of an object with a color picker. If the sharpness of the background object is decreased, the blur looks more natural.

## Improved Microphone Sound Quality

### ❖ New Supplied Monaural Microphone ECM-XM1

The supplied ECM-XM1 microphone's S/N ratio is 78 dB, a sensitivity increase of 14 dB over its predecessor, the ECM-NV1\*6.

\*6 The ECM-NV1 is a supplied microphone with DSR-PD170, DSR-250, HVR-A1U and HVR-V1U.

Microphone	ECM-XM1	ECM-NV1
Sensitivity (at 1kHz)	-30 dB±3.5 dB*7	-44 dB±4.0 dB
Signal-to-noise ratio	78 dB, typical	70 dB
Frequency Response	50~20,000 Hz	100~15,000 Hz
Maximum input sound pressure level*8	127 dB SPL, typical	121 dB SPL
Dynamic Range	111 dB, typical	97 dB

\*7 0 dB=1 V/Pa, at 1 kHz

\*8 0 dB SPL=20 μ Pa.

# Selectable Progressive Modes

The HVR-Z7U and HVR-S270U have two types of progressive shooting modes.

## ❖ 24p/30p HDV Native Progressive Recording Modes **PROGRESSIVE**

The HVR-Z7U and HVR-S270U camcorders newly feature 24p/30p HDV native progressive recording modes. The 3 ClearVid CMOS Sensor system and EIP create true 1080p images, which can then be recorded as progressive signals by the HVR-Z7U and HVR-S270U camcorders in HDV format.

The progressive HDV stream can be output from an i.LINK connector and used for progressive editing with compatible NLE software.

Native progressive recording modes are suitable for output to film, CG composition, viewing on a progressive monitor, or as an Internet movie.

Note: Interlaced video is output from connectors other than i.LINK

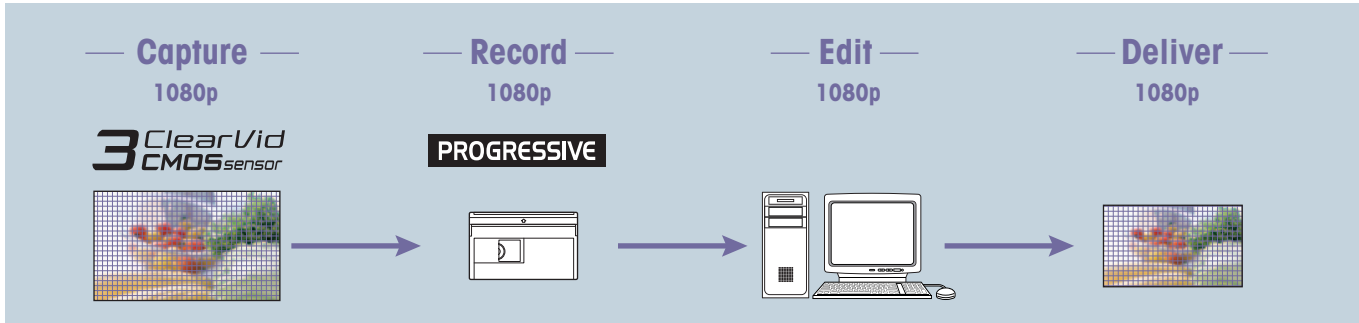

## ❖ 24p/30p Progressive Scan Modes

In these modes, the 1080p image captured by the 3 ClearVid CMOS Sensor system is also recorded as an interlaced signal by dividing each frame into two fields. This enables compatibility with current editing and monitoring equipment that only accept interlace signals, while maintaining the quality of the 1080p image. When using the "24p scan" setting, captured images are recorded as 60i through means of 2-3 pull-down. Progressive scan modes are suitable for feature films, documentaries, and music videos, which have to be recorded as interlaced video for viewing on interlaced monitors, but want to offer a "progressive look" to their motion.

It is also possible to edit footage recorded in the "24p scan" mode as progressive material.

NLE software that is compatible with the "24p scan" mode can remove the 2-3 pull-down, then edit the footage as 24p material.\*5

For 30p, most NLE software can output the edited timeline in progressive format by merging odd and even fields.

\*5 When 24p editing is needed with the "24p scan" mode, be sure to select the "24A" setting in the "Scan Type" menu instead of the "24" setting. This setting records the 2-3 pull-down identification data in the HDV stream, so that compatible NLE software knows when to remove the 2-3 pull-down cadences. In the 24A setting, interruptions in time code and video may appear between recordings when viewed on an HDV device. There is no "24A" setting in DV CAM and DV modes.

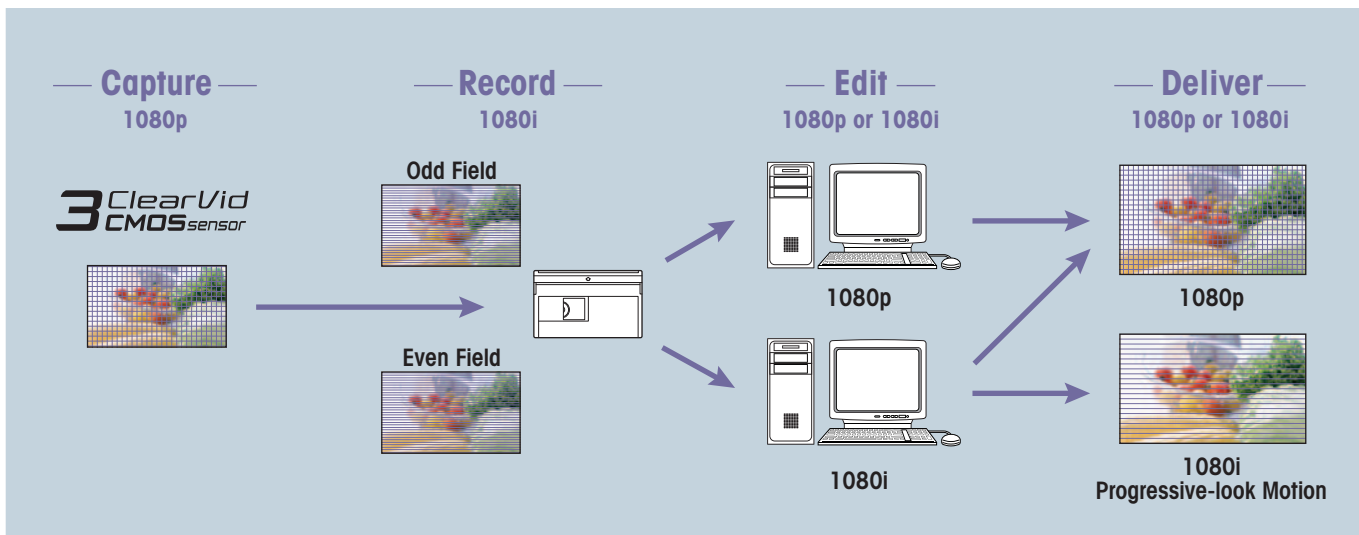

## Memory Recording Unit

### ❖ HDV in IT Workflow by CompactFlash Memory Recording Unit

The Memory Recording Unit is supplied with each camcorder to support HDV tape recording. It captures the HDV1080i, DVCAM, or DV stream output from the camcorder and records it as movie file while you are simultaneously recording to tape. You can use a standard CompactFlash (CF) card\*, which offers secure recording, high-speed access, large data capacity, removable media convenience, and high durability against external vibration.

\*Not supplied.

The CF card is used for HDV camcorders because the media is easily obtainable for file recording in the same way as miniDV tape is easily obtainable for HDV recording. This general versatility is very important for those who frequently need to obtain media quickly, such as someone shooting a documentary or news reports while moving from city to city.

### ❖ HDV/DVCAM/DV File Recording on Easily Obtained CompactFlash Card

The recording time on a 16-GB CF card\*<sup>9</sup> in HDV, DVCAM and DV format\*<sup>10</sup> is approximately 72 minutes.

CF card capacity	Recording time(approximately)
16GB	72 minutes
8GB	36 minutes
4GB	18 minutes
2GB	9 minutes

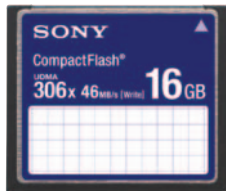

**72 min.**  
**16 GB**



\*<sup>9</sup> At least 133x speed and 2-GB capacity is required. The NCFD8GP and NCFD16GP Sony CF cards are recommended. The SONY CF card is recommended for use in the Memory Recording Unit. With other commonly-used CF cards, there may be rare occasions when data will not be recorded correctly depending on the products. If you use a CF card other than those recommended, it is advisable to test it in advance in the following way.

- 1) Format the CF card in the Memory Recording Unit.
- 2) Shoot more than 20 pieces of footage of about 10 seconds each in HDV recording mode.
- 3) Import the files into your nonlinear editing software to check if it can be edited properly.

\*<sup>10</sup> The recording time may change according to the CF card type and recording format.



### ❖ Integration Without Cabling

The Memory Recording Unit can be integrated to the HVR-Z7U or HVR-S270U without the need for cabling, simply by attaching it onto the special shoe connector\*<sup>11</sup>. This smart combination never interferes with shooting operations. The Memory Recording Unit automatically synchronizes with the recording action of the camcorder – i.e., when the camcorder starts or stops recording, so does the unit.

\*<sup>11</sup> The intelligent shoe connector inputs and outputs an HDV/DV stream and supplies power to the Memory Recording Unit. The i.LINK connector is not available when the unit is attached on the camcorder.



attached on the HVR-Z7U



attached on the HVR-S270U



## ✦ Hybrid Operation Realizes Archiving, IT Workflow, and HD/SD Parallel Recording

The Memory Recording Unit provides a hybrid operation, where images are recorded to tape and a CF card simultaneously, in a similar fashion to the HVR-DR60 Hard Disk Recording Unit\*12.

\*12 HVR-DR60 does not accept a native progressive HDV stream. When the Memory Recording Unit is used, the i.LINK connector of the camcorder is disabled.

This means you can immediately access a movie file for streamlined NLE work, while keeping the master source tape in a safe place.

The file format is M2T for HDV mode and AVI or RawDV for DVCAM/DV modes.

Mode	File Format
HDV	M2T
DVCAM/DV	DV-AVI(type 1) or Raw-DV

In the same fashion as HVR-DR60 operation, these files can be edited using popular NLE software.\*13

\*13 The Memory Recording Unit and HVR-DR60 adopt the FAT32 file system. Continuous recording is divided into 4-GB files (approximately 20 minutes of recording time). A utility software, available from the Sony website, can merge these divided files for seamless editing on NLEs. Some NLEs include this function. For details of NLE operation, please consult your nearest NLE software dealer.

In addition, when the built-in down-converter of the connected HDV camcorder is active, SD images can be recorded on a CF card while HD images are recorded to tape.

HD master tape is recorded and SD movie files are created at the same time.

HDV or DVCAM tape-based users can gradually move to IT workflow with this hybrid-operation.

Tape-less recording is also available if desired.

### Hybrid-Recording

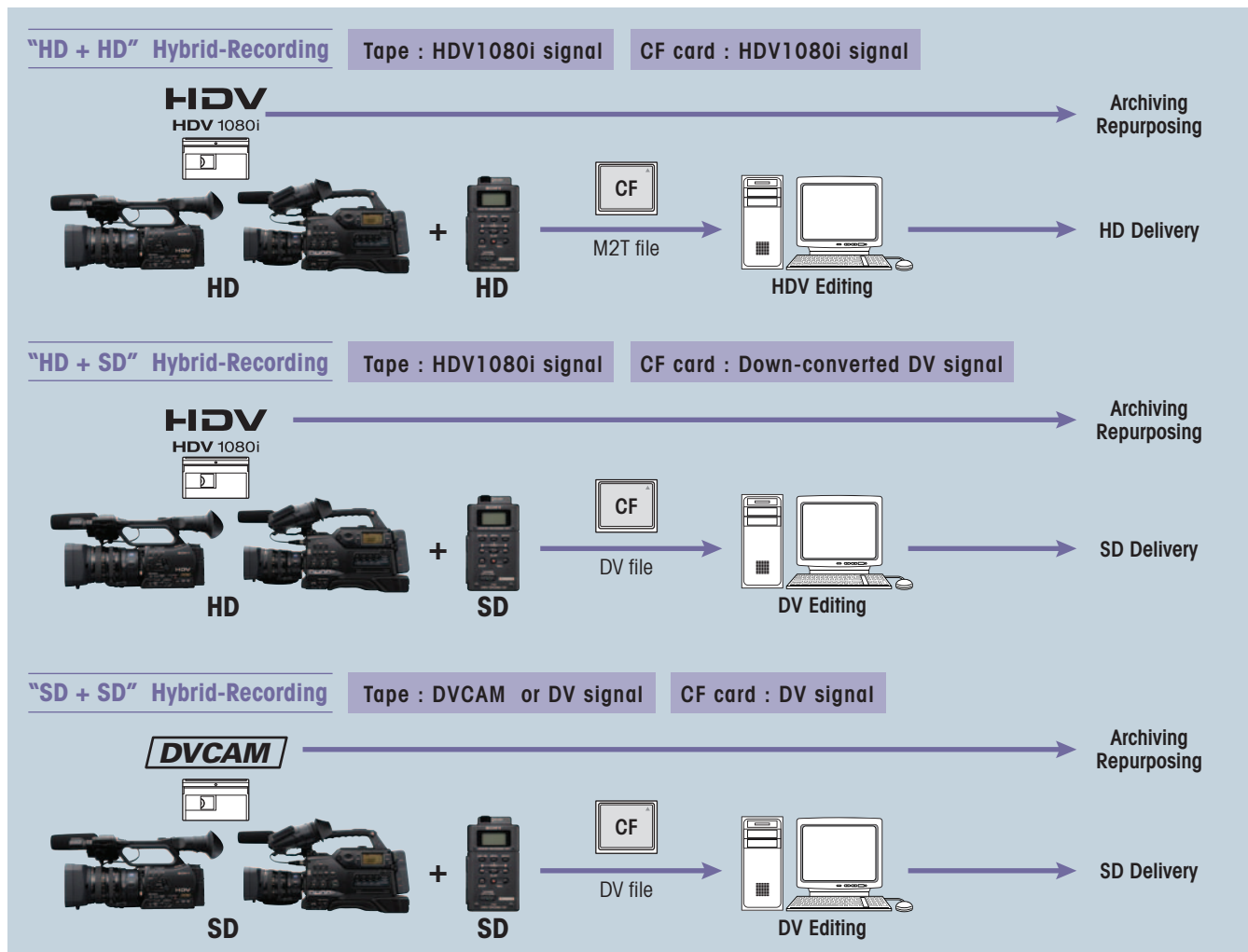

■ File Transfer

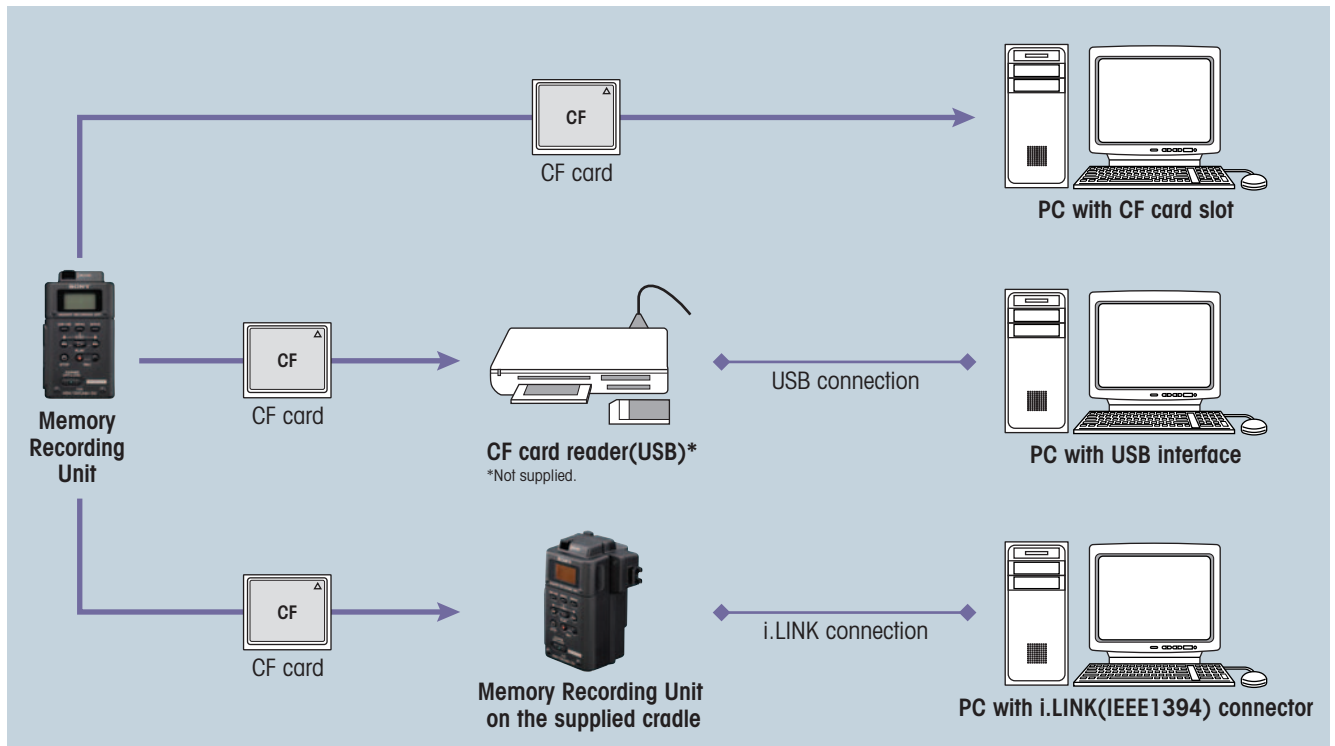

■ Playback from the Memory Recording Unit

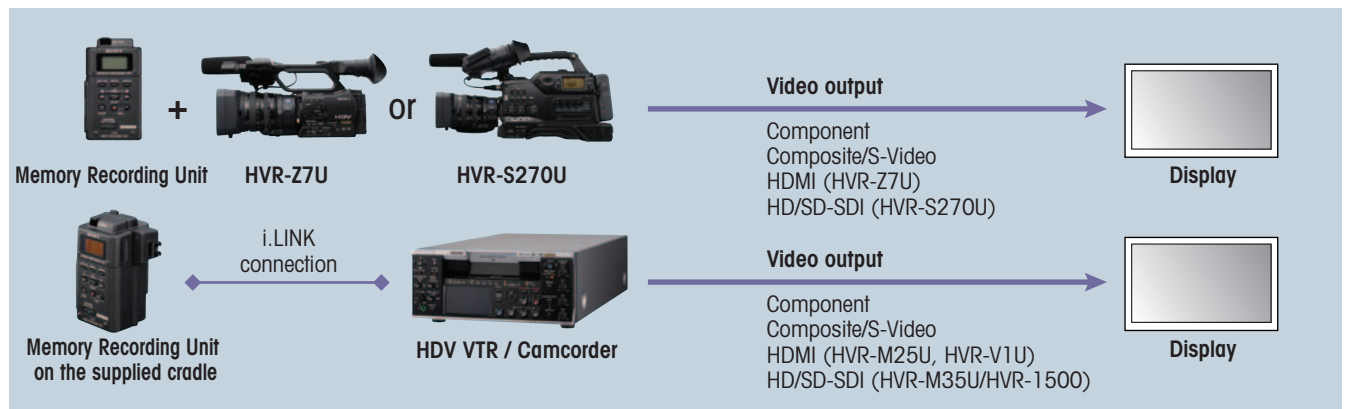

Note: Interruptions in video out put may appear between recordings during playback through the connected HDV/DVCAM/DV device.

✦ Independent Use With the Supplied Cradle

The Memory Recording Unit can be used as an external recording unit, just like the HVR-DR60, by attaching the supplied cradle that has an i.LINK connector, battery attachment, and DC power input. When the Memory Recording Unit is connected to a compatible PC via the i.LINK connector, it is recognized as an external drive and can be used to access files. When connected to a compatible video device (such as a VTR or NLE system) via the i.LINK connector, it can be used to input/output a HDV/DVCAM/DV stream.



# HVR-Z7U Camcorder

Sony's new HVR-Z7U is the world's first professional handheld HDV camcorder with an interchangeable lens system. The compact design makes it easy to use and flexible when shooting applications requiring mobility and in space-constrained locations.



## ✦ HDV, DVCAM and DV Recording on a miniDV Cassette tape

The HVR-Z7U accepts miniDV cassette tapes, which provide over 60 minutes recording time for HDV and DV formats, over 40 minutes for DVCAM format.



Cassette compartment

## ✦ An Ideal Handheld Camcorder Design

Sony has responded to professional user feedback to create the ideal handheld camcorder with ergonomically designed body-weight balance and a well-planned layout of buttons and connectors to reduce camera operator fatigue.



## Operational Versatility of HVR-Z7U

### ✦ New XtraFine LCD and EVF Offer High-resolution, High-contrast Images

#### XtraFine LCD

A 3.2-inch (viewable area, measured diagonally) type XtraFine™ LCD is located on the HVR-Z7U in the same position as on the HVR-Z1U. The high pixel number of approximately 921,000 dots is around four times greater than the LCD of the HVR-Z1U, and this higher resolution allows for easier focus adjustments.

#### XtraFine EVF

The 0.45 inch type XtraFine EVF (Electronic View Finder) has approximately 1,227,000 dots (852x3(RGB)x480). This device has three independent LEDs for R, G, and B colors. This technology allows users to check objects with remarkable color reproduction and resolution\*. The EVF has a selectable display mode between color or black and white.

\*When the camcorder is panned quickly or when an object in the screen moves quickly, the primary colors of R/G/B may be seen on the object in the EVF momentarily.

#### Common Features of the XtraFine LCD and EVF

- 100% full-scan display – helps you to check the entire recorded area.
- 6500k color temperature – standard for professional monitors.



XtraFine LCD and EVF

(on screen image simulated)



## ❖ InfoLITHIUM L Series Battery Compatible

The HVR-Z7U uses the same InfoLithium® batteries as the HVR-Z1U, HVR-V1U, and DSR-PD170, so you can fully utilize your existing battery and charger assets.

## ❖ HDMI output connector

Uncompressed digital HD video and audio signals are output from the HDMI connector. You can see stunning HD images on the HDMI-compatible monitor display. During shooting, the pre-compressed 1920x1080i/4:2:2 signal is output from the HDMI connector.



## ❖ Smooth Slow Rec

The Smooth Slow Rec function of the HVR-Z7U camcorder enables slow-motion playback by capturing images four times faster than the normal field rate (240 fields/s). In this mode, quad-speed images are captured for three seconds, stored in the built-in buffer memory, and then recorded to tape (in either HDV, DVCAM, or DV format) as slow-motion pictures lasting 12 seconds\*<sup>15</sup>. This allows recorded images to be checked immediately in the field. Although the resolution of the picture quality is decreased, this function is effective for some applications that don't need full HD quality, such as Internet movies or the analysis of moving objects like a golf swing, for example.

### ■ Smooth Slow Rec

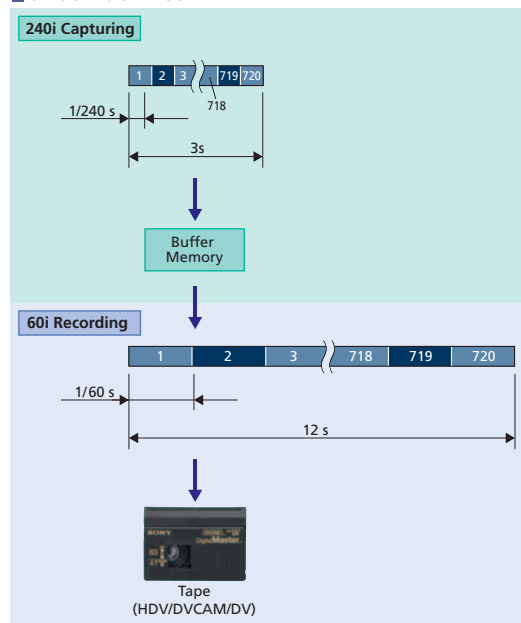

\*15 Audio cannot be recorded while shooting in this mode.

## ❖ Two Accessory Shoes

The HVR-Z7U features two accessory shoes. There is a cold shoe on the front that can be removed to make room for a mattebox. While at the rear, there is a screw-hole type shoe located on the handle, which can be changed to a cold shoe, if required, using supplied parts.



A:Removable Front Shoe B:Screw Hole



Removable Front Shoe



Rear cold shoe parts

## ❖ Two Screw Holes for Secure Connection

To provide a more secure connection between the camcorder and tripod plate or other accessories, two screw holes have been incorporated.

## ❖ One-touch Clip-type Microphone Holder

A one-touch clip-type microphone holder makes it easy to remove the microphone for quick storage.



Clip-type microphone holder

# HVR-S270U Camcorder

The HVR-S270U offers videographers a traditional "on-the-shoulder" feel with the benefits of increased camera stability and longer recording time of up to 4.5 hours with standard size cassettes.



## ❖ Standard-size Cassette Compatibility

A standard-size cassette tape provides approximately 4.5 hours of HDV/DV recording or approximately 3 hours of DVCAM recording. Of course, recording on a miniDV tape is still an option.

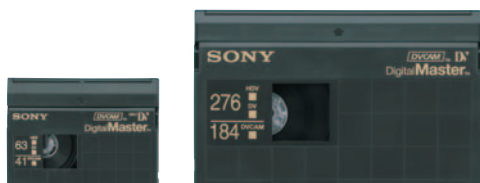

## ❖ HD/SD-SDI & Other Output Connectors

An HD/SD-SDI output connector provides embedded audio and TC data and can, for example, be linked up to an XDCAM HD deck.

BNC connectors provide secure cabling connections.



Rear panel



Connectors



Side panel

## ❖ Four-channel Audio Input

Four-channel audio recording is realized in HDV and DVCAM thanks to four XLR audio input connectors – two at the front, and two at the back.

## ❖ "Dual Finder" New LCD Position on EVF Unit

The new LCD position on the EVF (Electric View Finder) unit is currently only available on Sony's professional HDV shoulder-mount camcorders.

The HVR-S270U camcorder features a new configuration of a 3.2-inch (viewable area, measured diagonally) type XtraFine LCD monitor (approximately 921,000 dots) and an XtraFine EVF (approximately 1,227,000 dots, 852x3(RGB)x480)\*. The LCD is located on the EVF unit. This unique layout enables the camera operator to perform both traditional EVF monitoring and LCD monitoring, while the camcorder is held on the shoulder. The 180-degree tilt mechanism allows for LCD monitoring when the camcorder is held in a high or low-angle position, and the 270-degree swivel mechanism will allow LCD monitoring from the front, right, or even left of the camcorder so that a reporter or a director can monitor what is being captured by the camcorder.

\*When the camcorder is panned quickly or when an object in the screen moves quickly, the primary colors of R/G/B may be seen on the object in the EVF momentarily.



## ❖ BP Series Battery Compatible

V-lock professional BP batteries are another great feature in common with broadcast camcorders.

## ❖ Smooth Slow Rec

As with the HVR-Z7U, the HVR-S270U camcorder enables slow-motion playback by capturing images four times faster than the normal field rate (240 fields/s).

# HVR-M35U

The HVR-M35U is compatible with HDV native progressive recording modes and supports HD/SD-SDI output with embedded audio and TC data.



(Image simulated)

## ❖ HD/SD-SDI Output

The HD/SD-SDI output of HVR-M35U allows straight duplication to a deck with HD/SD-SDI input.

## ❖ Multi-format Playback/Recording Capability

The HVR-M35U supports HDV native progressive recording modes and has a 60i/50i switchable function, so it can playback/record:

- HDV1080i: 60i/50i/24p/30p/25p
- DVCAM/DV: 60i/50i

## ❖ Standard and Mini Size Cassette Tape Compatibility

Both standard- and mini-size cassette tapes are supported. It accepts standard cassettes shot on the HVR-S270U or other shoulder-mount DVCAM camcorders.



## ❖ Four Channel Audio Data Playback

The HVR-M35U can play back the four-channel audio data in HDV1080i format recorded by the HVR-S270U. It can also play back the four-channel audio data in DVCAM format. The four-channel audio data is embedded in the i.LINK and HD/SD-SDI output, or is output through the AES/EBU audio connectors.

## ❖ 2.7-inch Wide Clear Photo LCD plus Screen and Monaural Speaker

A built-in 2.7-inch type wide Clear Photo LCD plus™ screen and built-in monaural speaker allow quick and convenient checking of video and audio.

## ❖ Other Functions of the HVR-M35U

The HVR-M35U covers most functions of its lower-end model, the HVR-M25U.

### Down-conversion Playback Capabilities

The HVR-M35U can convert material from HD down to SD, and output the SD video signal through its i.LINK, SD-SDI, analog component, S-video, and composite connectors. This allows users to edit recorded material with a compatible nonlinear editing system using current DV editing software, as well as record SD signals to an external VTR.

When down-converting these signals, the aspect ratio displayed can be converted from 16:9 to 4:3. Display modes can be selected from Squeeze, Letterbox\*<sup>16</sup>, and Edge Crop\*<sup>16</sup>.

\*<sup>16</sup> Letterbox output is not available from the i.LINK connector. For the HDV recording with four channels audio data, the audio data in the down-converted DV signal is selectable from either 1/2ch or 3/4ch.

### Edge Crop Adjust

When down-converting signals in Edge Crop mode, you can use the Edge Crop Adjust function to adjust the edge crop position. By displaying the edge crop marker on the LCD monitor, operators can conveniently check the edge crop position before outputting down-converted signals.

### DUPLICATE PLUS

The DUPLICATE PLUS function makes it easy to copy video and audio from a VTR or camcorder onto the HVR-M35U – along with the original time code. Operators simply connect the two i.LINK devices together via their i.LINK interfaces and press the DUPLICATE PLUS and PLAY buttons on the front panel of the HVR-M35U. Copying will then begin.





Front

(image simulated)



Rear

## Accessories

### New Optional Wide Lens

VLCL-308BWH (for HVR-Z7U)\*  
VLCL-308BWS (for HVR-S270U)\*

### New $\alpha$ lens adaptor

LA-100W\*

\* For the detail on the release date, please contact your nearest Sony office or authorized dealer.

### CompactFlash Card

NCFD16GP 16GB 306x  
CompactFlash Card  
(planned availability Spring 2008)  
NCFD8GP 8GB 306x  
CompactFlash Card



### New VCT-SP1BP

Camcorder Support (HVR-Z7U)

- Weight support for stable/comfortable shooting
- Support for several shooting styles (e.g., high-angle shooting)
- Quick-release function from harness for excellent mobility
- Perfect design for camcorder Monopod
- Carbon shaft for light weight and rigid design
- RM-1BP Remote Controller supplied as standard



### New AC-VQL1BP

AC Adaptor Charger (HVR-Z7U)

- 4 slots battery charger (A pair of parallel charge)
- 2 charge mode selectable (Normal/Full)
- Charging information  
Remaining time to charge complete  
Current available time for shooting
- Battery Log information  
Total charge time  
Total charge cycle  
last operation date



### New SH-L32WBP

LCD Hood (HVR-Z7U/S270U)

- LCD Hood for 3.2" LCD monitor
- Adjustable shade (360° shade)
- Folding structure realize transfer with camcorder



### HVR-DR60

Hard Disk Recording Unit

An external Hard Disk Recording Unit with a 60GB capacity and 4.5 hours of recording time for HDV, DVCAM and DV. (battery is not supplied)



### HVL-LBP

LED Battery Video Light (HVR-Z7U/S270U)

- LED reliability and low power consumption of 16W
- Battery power from NP-F770/F970
- Wide compatibility for flexible installation (Cold shoe/Screw bolt/Screw hole)
- Ideal for Wide-angle shooting and interviews  
Spot (600lx@1m) or flood-lighting (300lx@1m) with attached condensing lens ON or Off
- Light diffuser attached to soften shadows and reduce contrast
- Long Operating time: approximately 3 hours with the NP-F970 (at maximum brightness)



### VCT-U14

Tripod Adaptor (HVR-S270)

### RM-1BP

LANC remote controller (HVR-Z7U/S270U)

### BP-GL95/GL65/L60S/L80S

Lithium-ion Battery Pack (HVR-S270U)

### BC-L70/M150/L500

Battery Charger (HVR-S270U)

### AC-DN10

AC Adaptor (HVR-S270U)

### 2NP-F970/B

InfoLITHIUM Rechargeable Battery Pack (2 pack) (HVR-Z7U)

### NP-F970/F770/F570

InfoLITHIUM Rechargeable Battery Pack (HVR-Z7U)

### VCT-PG1TRMB

Tripod with RM-1BP Remote Controller (HVR-Z7U)

## Specifications (HVR-Z7U,HVR-S270U)

		HVR-Z7U	HVR-S270U
<b>Camera section</b>			
Supplied lens		Carl Zeiss Vario-Sonnar T* zoom lens, 12x (optical), f = 4.4 to 52.8 mm, f = 32.0 to 384 mm* at 16:9 mode f = 39.5 to 474 mm* at 4:3 mode, filter diameter: 72 mm	
Built-in filter		Clear, 1/4, 1/16, 1/64	
Imaging system		1/3-inch, progressive 3 ClearVid CMOS Sensor system with technology of Exmor	
Picture elements		Approx. 1,037,000 pixels (effective), approx. 1,120,000 pixels (total)	
Focus		Auto, manual (focus ring/one push auto/infinity/AF assist/ focus macro)	
White balance		Auto, one-push auto (A/B positions), indoor (3200 K), outdoor (selectable level -7 to +7, approx. 500K/step), manual WB Temp (selectable 2300K to 15000K, 100K/step)	
Manual shutter speed	Auto	1/60 - 1/2000	
	Manual	60/30p: 1/4 - 1/10000 24p: 1/3 - 1/10000	
Gain		-6, -3, 0, 3, 6, 9, 12, 15, 18, 21 dB	
Minimum illumination		1.5 lux (auto gain, auto iris, 1/30 shutter)	
<b>VTR section</b>			
Recording format		HDV1080/60i, 1080/24p, 1080/30p, DVCAM, DV SP 480/60i (NTSC)	
Play out/Down conversion format		HDV1080/60i, 1080/24p, 1080/30p, DVCAM, DV SP 480/60i (NTSC)	
Playback/Recording time	HDV/DV SP	Max. 63 min with PHDVM-63DM cassette	Max. 276min with PHDV-276DM Max. 63 min with PHDVM-63DM cassette
	DVCAM	Max. 41 min with PHDVM-63DM cassette	Max. 184min with PHDV-276DM Max. 41 min with PHDVM-63DM cassette
<b>Input/Output connectors</b>			
Audio/Video output		10-pin connector A/V OUT jack (composite, unbalanced audio x2ch with the supplied cable)	Composite video (BNCx1) Unbalanced audio (pin x2ch)
Component video output		Component out jack (special connector)	BNC x3
HDV/DV input/output		i.LINK interface (IEEE 1394, 6-pin)	
XLR audio input		XLR 3-pin female x 2ch	XLR 3pin female x 4ch
Headphone		Stereo mini jack (ø3.5 mm)	
LANC		Stereo mini-mini jack (ø2.5 mm)	
Digital video output		HDMI connector	HD/SD-SDI BNC x1
<b>Built-in output devices</b>			
LCD view finder		0.45-inch type (Viewable area measured diagonally), approx. 1,226,880 dots (852x3(RGB)x480), 16:9 aspect ratio	
LCD monitor		3.2-inch type (Viewable area measured diagonally), XtraFine LCD, approx. 921,600 dots, hybrid type, 16:9 aspect ratio	
<b>General</b>			
Weight		Approx. 5 lb 4 oz (2.4 kg) (w/ the supplied lens, w/o tape, battery)	Approx. 13 lb 15 oz (6.3 kg) (w/ the supplied lens, w/o tape, BP-GL95battery)
Dimension (W x H x D)		Approx. 6 15/16 x 7 13/16 x 17 9/32 inch (176 x 199 x 439 mm) (With lens hood, microphone and large eye cup.)	Approx. 12 1/8 x 10 5/8 x 20 inch (305 x 267 x 505 mm) (With lens hood.)
Power requirements		DC 7.2 V (battery pack), DC 8.4 V (AC adaptor)	
Power consumption	HDV	Approx. 7.2 W (with ECM-XM1 / LCD EVF ON)	
	DVCAM/DV	Approx. 6.9 W (with ECM-XM1 / LCD EVF ON)	
Battery operating time *(recording mode)	HDV	VF=ON	390min(NP-970)
		VF=ON MRC1=ON	290min(NP-970)
	DVCAM/ DV	VF=ON	410min(NP-970)
		VF=ON MRC1=ON	295min(NP-970)
Operating temperature		32 to 104 °F (0 to 40 °C)	
Storage temperature		-4 to 140 °F (-20 to +60 °C)	
Supplied accessories		AC-VQ1050 AC adaptor/charger, NP-F570 infoLITHIUM rechargeable battery pack, A/V connecting cable, component video cable, lens hood with lens cover, lithium battery (CR2025), shoe adaptor, large size eye-cup, additional normal shoe kit, RMT-831 wireless Remote Commander, ECM-XM1 monaural electrolet condenser microphone Operating instructions (CD-ROM) Printed operating instructions, HVR-MRC1 memory recording unit kit	lens hood with lens cover, large size eye-cup, additional normal shoe kit, ECM-XM1 monaural electrolet condenser microphone, Shoulder Belt, Operating instructions (CD-ROM), Printed operating instructions, HVR-MRC1 memory recording unit kit
<b>Supplied memory recording unit (HVR-MRC1)</b>			
Recording media		CompactFlash card (2GB or bigger, 133x or faster)	
File system		FAT32	
File format	HDV	.M2T	
	DVCAM/DV	.AVI (DV-AVI, type 1) or .DV (Raw-DV)	
Connectors		special hot shoe i.LINK-6pin (on the supplied cradle) DC power input (on the supplied cradle) infoLITHIUM L series battery slot (on the supplied cradle)	BNC x1 RCA pin x 4ch XLR 3pin x 4ch RCA pin x 1 BNC x2 BNC x1 Stereo minijack (ø3.5 mm) Stereo mini-minijack (ø2.5 mm) Stereo minijack (ø3.5 mm) 2.7-inch type (Viewable area measured diagonally), approx. 211,200 dots (960 x 220), Clear Photo™ LCD Plus

## Specifications (HVR-M35U)

Recording/playback performance		
Recording format	HDV	HDV1080/60i, 1080/50i, 1080/24p, 1080/25p, 1080/30p
	DVCAM / DV SP	DVCAM, DV SP 480/60i (NTSC), 576/50i (PAL)
Playout format	HDV	HDV1080/60i, 1080/50i, 1080/24p, 1080/25p, 1080/30p
	DVCAM / DV SP	DVCAM, DV SP 480/60i (NTSC), 576/50i (PAL)
Playout video signal		1080/60i, 1080/50i, 480/60i (NTSC), 576/50i (PAL), 480/60P, 576/50P
Tape speed	HDV/DV SP	Max. 18.812 mm/s
	DVCAM	Max. 28.218 mm/s
Playback/recording time	HDV/DV SP	Max. 276 min with PHDV-276DM cassette Max. 63 min with PHDVM-63DM cassette
	DVCAM	Max. 184 min with PHDV-276DM cassette Max. 41 min with PHDVM-63DM cassette
		Approx. 2 min with PHDV-276DM cassette
Fast forward/rewind time		
Input/output connectors/devices		
Video input/output		BNCx1 / BNCx1
Monitor video out		RCA pin x1
S-video input/output		Mini-DIN 4-pin x1 / Mini-DIN 4-pin x1
Component video output		BNC x 3
i.LINK interface (HDV /DV)		6-pin (no power)

HD/SD-SDI output	XLR 3pin x 4ch
Audio input	RCA pin x 1
Audio output	BNC x2
Monitor audio out	BNC x1
AES/EBU output	Stereo minijack (ø3.5 mm)
TC out	Stereo mini-minijack (ø2.5 mm)
Phones	Stereo minijack (ø3.5 mm)
LANC	2.7-inch type (Viewable area measured diagonally), approx. 211,200 dots (960 x 220), Clear Photo™ LCD Plus
Control S input	
LCD monitor	
Approx. 9 lb 12 oz (4.4 kg)	
General	Approx. 8 3/8 x 3 1/2 x 15 3/8 inch (212 x 88 x 390.3 mm)
Weight	AC 120 V, 60 Hz
Dimension (WxHxD)	15 W (playback mode with LCD monitor on)
Power requirements	41 to 104 °F (5 to 40 °C)
Power consumption	-4 to 140 °F (-20 to +60 °C)
Operating temperature	Remote Commander Unit (1), power cord (1)
Storage temperature	cleaning cassette (1), operating instructions (1)
Supplied accessories	

**SONY**<sup>®</sup>

Sony Electronics Inc.  
1 Sony Drive  
Park Ridge, NJ 07656  
[www.sony.com/HDV](http://www.sony.com/HDV)

V-2395-C (MK10452V1)

© 2007 Sony Electronics Inc. All rights reserved.

Reproduction in whole or in part without permission is prohibited.

Features and specifications are subject to change without notice.

All non-metric weights and measurements are approximate. Sony, DVCAM, ClearVid,

Exmor, Enhanced Imaging Processor, DigitalMaster, SteadyShot, i.LINK, InfoLITHIUM, Memory Stick Duo, ,

XDCAM, XtraFine, Picture Profile, Shot Transition, Clear Photo LCD Plus are trademarks of Sony.

<sup>3</sup> ClearVid logo is a trademark of Sony Corporation. HDV and the HDV logo are trademarks of Sony Corporation and Victor Company of Japan, Limited. Zeiss, Vario-Sonnar T\* and their respective logos are trademarks of Carl Zeiss AG.

Printed in USA 8/08